

en Owners Manual

EVlink Pro DC 60 Charging Station

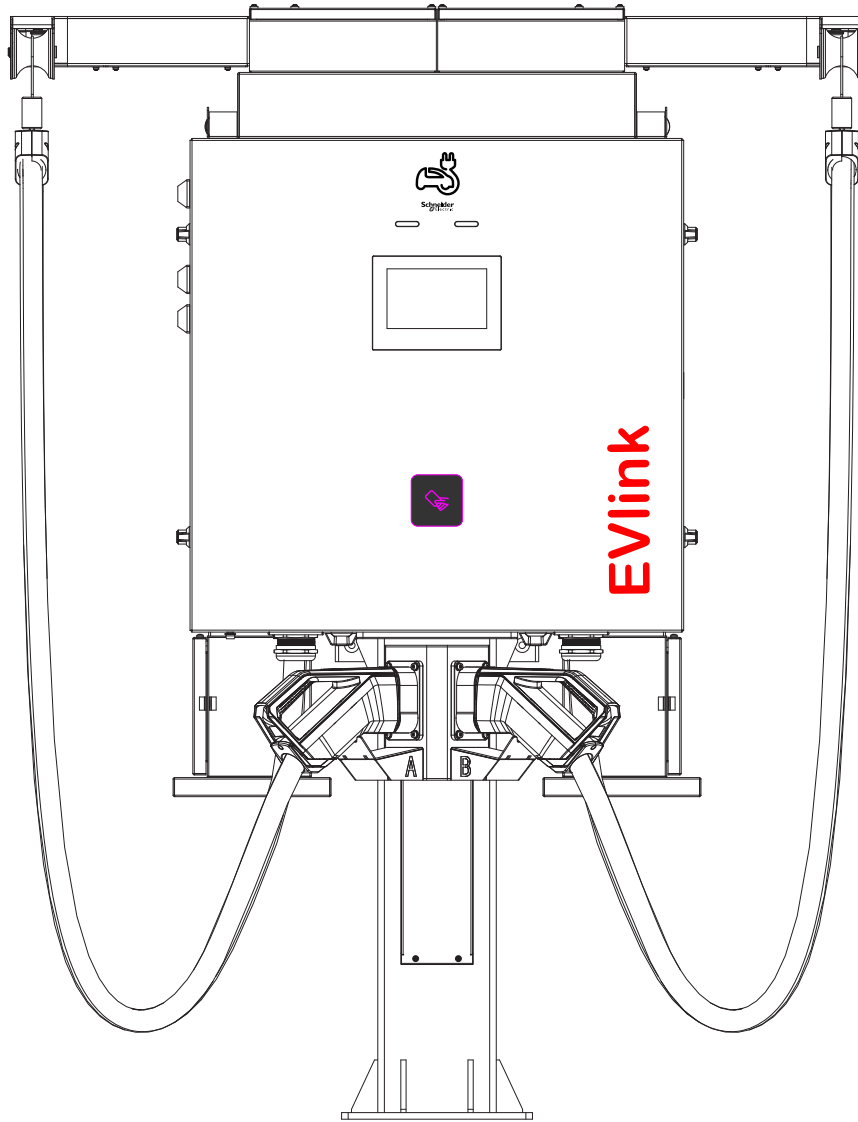

Customer Care Center



- Legal Information.....2**
- General3**
- Preface.....4**
- 1 System Overview.....5**
 - 1.1 Charging Stations Configurations 5
 - 1.2 Authentication Modes 6
 - 1.3 LED Status Indicator..... 6
 - 1.4 Languages..... 6
 - 1.5 Charge Session DC Meter Reading 7
- 2 User Instructions.....7**
 - 2.1 Basic Charging Steps 7
 - 2.2 Charging Authentication Modes..... 8
- 3 Consumption Statistics10**
 - 3.1 Charging Session Statistics..... 10
 - 3.2 Charge Session Report 10
- 4 Preventive Maintenance 11**
 - Regular Maintenance..... 11
- 5 Recycle.....12**

Legal Information



The Schneider Electric brand and any trademarks of Schneider Electric SE and its subsidiaries referred to in this guide are the property of Schneider Electric SE or its subsidiaries.

All other brands may be trademarks of their respective owners.

This guide and its content are protected under applicable copyright laws and furnished for informational use only.

No part of this guide may be reproduced or transmitted in any form or by any means (electronic, mechanical, photocopying, recording, or otherwise), for any purpose, without the prior written permission of Schneider Electric.

Schneider Electric does not grant any right or license for commercial use of the guide or its content, except for a non-exclusive and personal license to consult it on an "as is" basis.

Schneider Electric products and equipment should be installed, operated, serviced, and maintained only by qualified personnel.

As standards, specifications, and designs change from time to time, information contained in this guide may be subject to change without notice.

To the extent permitted by applicable law, no responsibility or liability is assumed by Schneider Electric and its subsidiaries for any errors or omissions in the informational content of this material or consequences arising out of or resulting from the use of the information contained herein.

General

Warning Symbols Definitions

The following safety messages may appear throughout this manual or on the equipment to warn of potential hazards or to call attention to information that clarifies or simplifies a procedure.



The addition of this symbol to a "Danger" or «Warning» safety message indicates that an electrical hazard exists which will result in personal injury if the instructions are not followed.



This is the safety alert symbol. It is used to alert you to potential personal injury hazards. Obey all safety messages with this symbol to avoid possible injury or death.

⚠ DANGER

DANGER indicates a hazardous situation which, if not avoided, will **result in** death or serious injury.
Failure to follow these instructions will result in death or serious injury.

⚠ WARNING

WARNING indicates a hazardous situation which, if not avoided, **could result in** death or serious injury.
Failure to follow these instructions can result in death, serious injury, or equipment damage.

⚠ CAUTION

CAUTION indicates a hazardous situation which, if not avoided, **could result in** minor or moderate injury.
Failure to follow these instructions can result in injury or equipment damage.

NOTICE

NOTICE is used to address practices not related to physical injury. The safety alert symbol shall not be used with this type of safety message.
Failure to follow these instructions can result in equipment damage.

Safety Instructions

⚠⚠ DANGER

HAZARD OF ELECTRICAL SHOCK, EXPLOSION OR ARC FLASH

- Read and follow all warnings and instructions before installing and operating the EVlink Pro DC Charging Station. Install and operate only as instructed. Failure to do so may lead to death, injury, or property damage, and will void the Limited Warranty.
- The product must be installed according to the specifications and requirements as defined by Schneider Electric. No responsibility is assumed by Schneider Electric if these requirements are not respected.
- Always inspect the Charging Station for proper installation before use.
- Always ground the EVlink Pro DC Charging Station. Failure to ground the charging station can lead to risk of electrocution or fire. The charging station must be connected to a grounded, metal, permanent wiring system, or an equipment grounding conductor shall be run with circuit conductors and connected to the equipment grounding terminal.
- Install the EVlink Pro DC Charging Station on a concrete pad according to the Schneider Electric approved method. Failure to install on a surface that can support the full weight of the charging station can result in death, personal injury, or property damage.
- This charging station is not suitable for use in or around hazardous locations, such as near flammable, explosive, or combustible materials.
- The use of extension DC cables or vehicle connector adapters is not permitted.
- Do not install the EVlink Pro Charging Station until all construction work has been completed and the installation area has been cleared & cleaned.
- Do not use this product if the enclosure, Electric Vehicle cable, or the Electric Vehicle connector is broken, cracked, open, or shows any other indication of damage.
- Do not put fingers into the electric vehicle connector.

Failure to follow these instructions will result in death or serious injury.

⚠ CAUTION

HAZARD OF DEGRADATION OF EQUIPMENT PERFORMANCE

- Under no circumstances will compliance with the information in this manual relieve the user of his/her responsibility to comply with all applicable codes or safety standards.
- Schneider Electric is not responsible for any damages that may result from custom installations that are not described in this document or for any failure to adhere to installation recommendations.

Failure to follow these instructions can result in injury or equipment damage.

NOTICE

RISK OF DAMAGING

- Before installing the EVlink Pro DC Charging Station, consult with a licensed contractor, such as a licensed electrician, and use a trained installation expert to ensure compliance with local building and electrical codes and standards, climate conditions, safety standards, and all applicable codes and ordinances.
- A qualified person is one who has skills and knowledge related to the construction, installation, and operation of electrical equipment and has received safety training to recognize and avoid the hazards involved.

Failure to follow these instructions can result in equipment damage.

Preface



This guide describes the operation and maintenance of the EVlink Pro DC 60 Charging Stations.

The EVlink Pro DC Charging Stations are easy to install DC fast Charging Stations for electric vehicles. Fast Charging Stations are electrical installations with high electric currents.

Therefore, any maintenance must be planned carefully, and must be done by certified personnel only (according to local standards).

Document Application

This document serves:

Site operators responsible for the charger's operation on site, performing regular inspection and maintenance activities and who are able to perform simple maintenance activities.

The Electric Vehicle drivers who will mainly use the Icons and texts on the HMI display of the charger.

However, the user interface design facilitates the user experience & it is easy to use the Charging station by following the instructions on the HMI screen.

Other Available Documentation

EVlink Pro DC available documents for each phase of the project:

Document	Content	Audiences
EVlink Pro DC 60 Datasheet	Full Charging Station specifications	Site designer, installer and station operator
EVlink Pro DC 60 Installation Guide	Civil, mechanical, and electrical installation guidelines	Site engineer or Installer/Contractor

Owner Responsibilities

The owner and/or site operator are required:

- To ensure the site where the Charging Station will be installed, is in accordance to the requirements described in the Installation guide.
- To ensure enough space around the Charging Station to carry out maintenance work.
- To ensure all protective devices are correctly installed after carrying out installation or maintenance.
- To operate the Charging Station with the protective devices installed.
- To write an emergency plan that instructs people what to do in case of emergency.
- To appoint a person responsible for the safe operation of the charge station and for the coordination of all work. This person should be properly trained by Schneider Electric Field Services.
- To contact Schneider Electric Services for the periodic maintenance of the Charging station at least once a year if not subscribed to a service plan.

1 System Overview

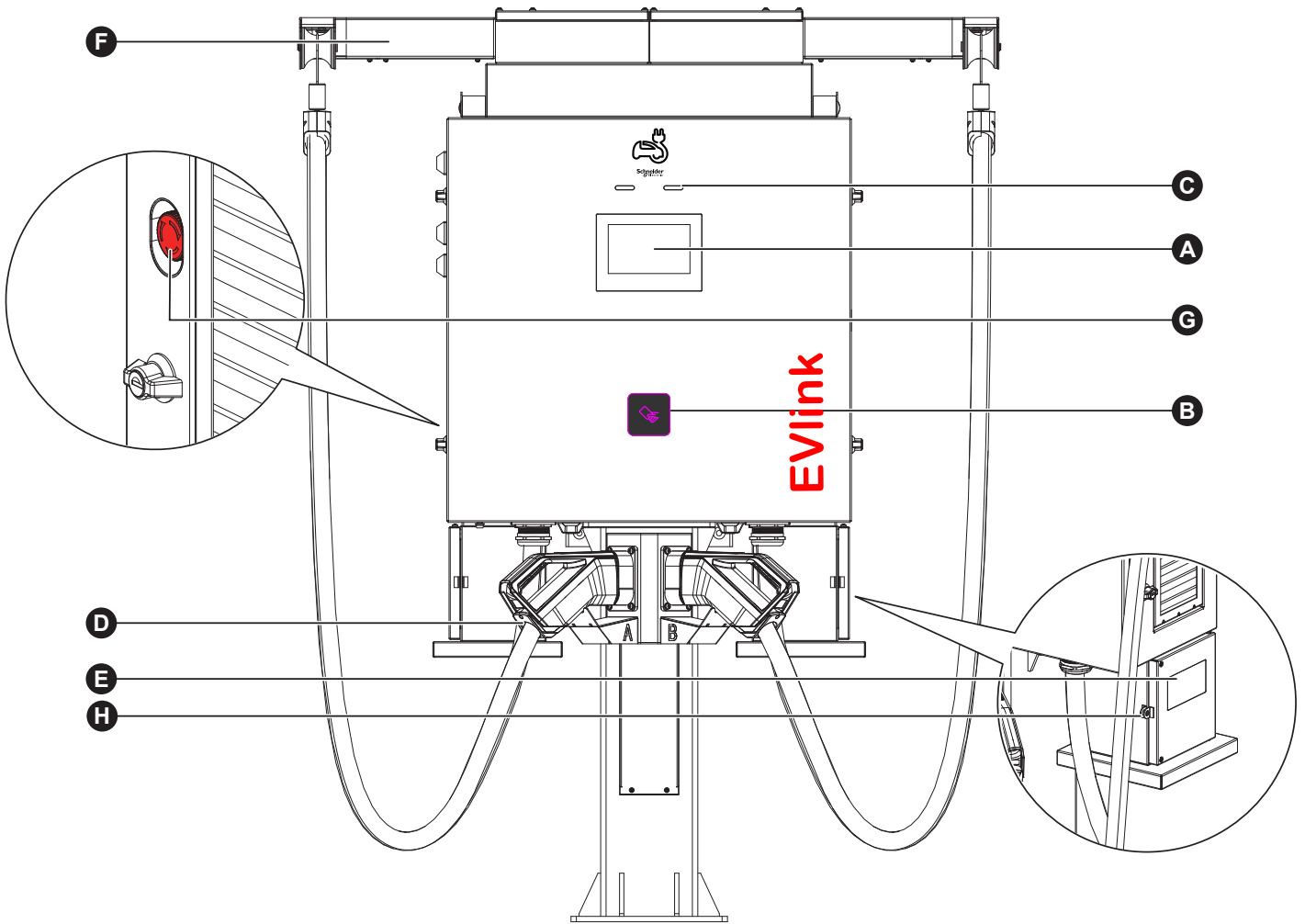

A	Touch screen
B	Card tapping area
C	Indicator lights
D	Vehicle connector slot
E	DC Electric meter
F	Cable Management System
G	Emergency Charge Stop
H	Lock ring*

*for padlock if required

1.1 Charging Stations Configurations

Commercial Reference (CR)	Nominal Power	Vehicle connector	Cable management	Cable range (m)
EVD1S60TBB	60 kW DC	2 x CCS2	Yes	3.5
EVD1S60THB	60 kW DC	1 x CCS2 + 1 x CHAdeMO	Yes	3.5
EVD1S60TBBC5	60 kW DC	2 x CCS2	No	5
EVD1S60THBC5	60 kW DC	1 x CCS2 + 1 x CHAdeMO	No	5
EVD1S60TBBC7	60 kW DC	2 x CCS2	No	7
EVD1S60TBB-AN	60 kW DC	2 x CCS2	Yes	3.5
EVD1S60THB-AN	60 kW DC	1 x CCS2 + 1 x CHAdeMO	Yes	3.5
EVD1S60TBBC7-AN	60 kW DC	2 x CCS2	No	7
EVD1S60TBB-SA	60 kW DC	2 x CCS2	Yes	3.5

1 System Overview

1.2 Authentication Modes

According to the Commissioning parameters, the EVlink Pro DC 60 operation is possible with or without authentication. Operation with authentication requires a Charging Station connected to an OCPP backend platform. Authentication mode needs to be defined at commissioning. Default mode is authorize registered RFID/NFC card.

Authentication modes available:

- Authorize registered RFID/NFC card/QR code
- No authentication required
- Authentication with Electric Vehicle MAC address/QR code

1.3 LED Status Indicator

The status of the EVlink Pro DC charging station is indicated via colored LED indicator lights. Below you will find the definition of each Indicator Light and its corresponding charger status and the basic user guidance: (Sticker provided with the unit)

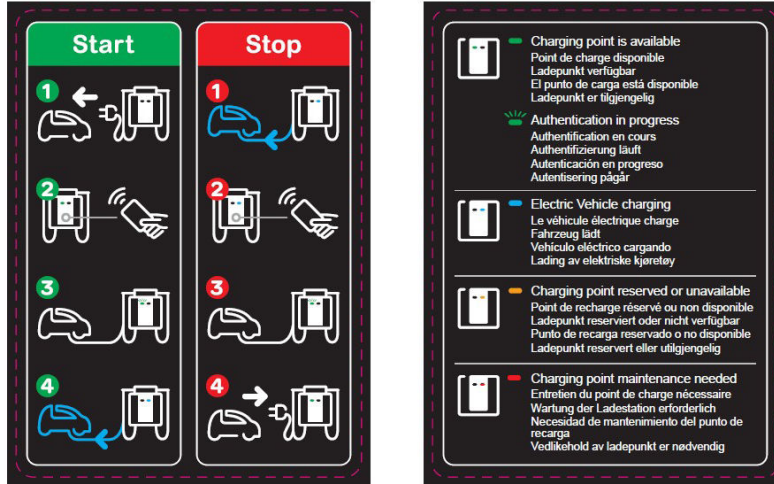

1.4 Languages

NOTE: The displayed languages on the screen can be customized during commissioning according to local requirements) The EVlink Pro DC User interface is integrated in several languages to facilitate the use according to regional requirements and enable different users. In the top right corner of the HMI screen you can press on the Flag icon which will take you to a menu to select your preferred language

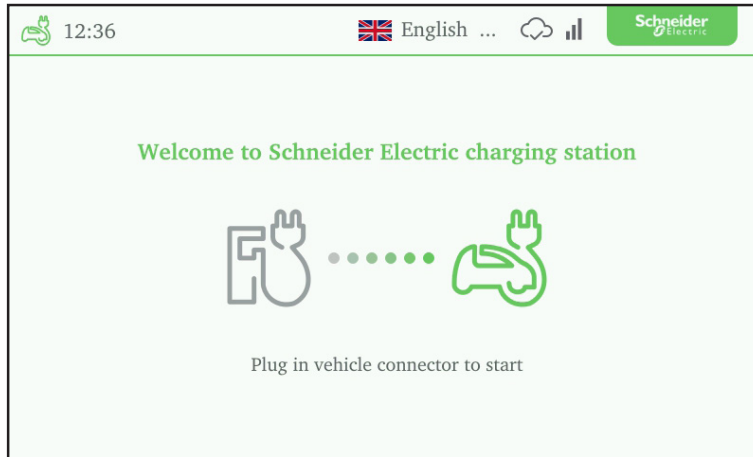

Available Languages:

NOTE: Image is for reference only as more languages are available to select during commissioning.

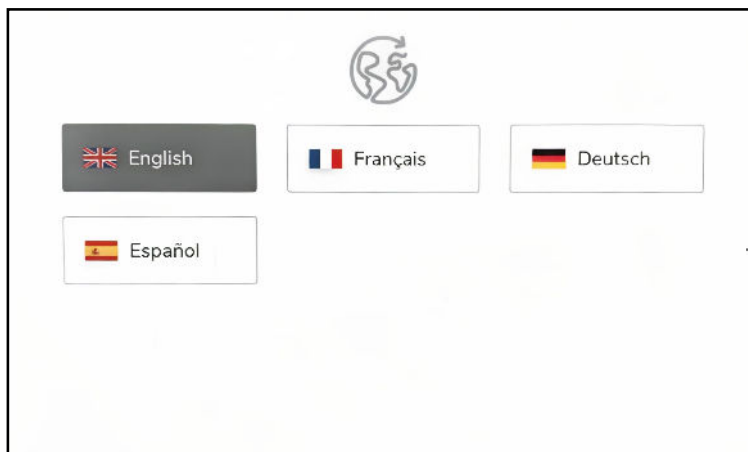

1 System Overview

1.5 Charge Session DC Meter Reading

The EVlink Pro DC Charging Station is equipped with a visible DC meter on each outlet. It provides the measurement data records with timestamp, loading process data and digital signature, thereby enabling charging processes to be billed in accordance with the legal requirements. Furthermore, all charging processes are persistently stored in the internal data storage of the meter.

The rotation interval on the display screen is 5 seconds.

Displayed Information:

- Total import mains energy
- Total import device energy

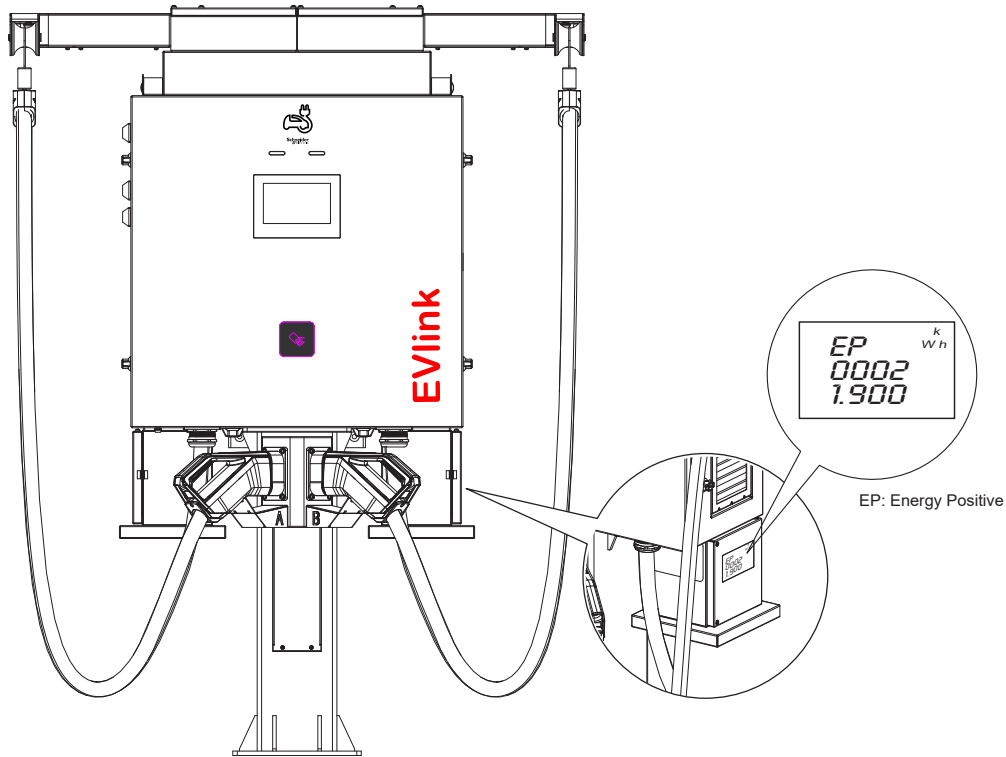

2 User Instructions

2.1 Basic Charging Steps

To charge an Electric Vehicle (EV):

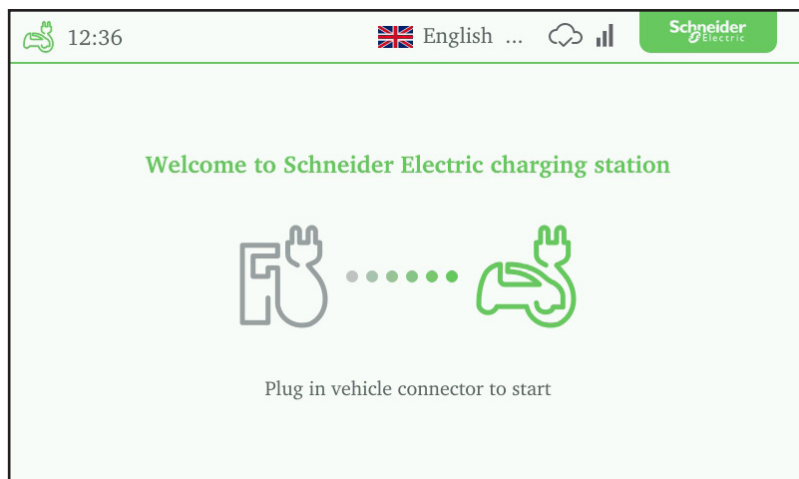

- Park the Electric Vehicle with the charge inlet within reach of the vehicle connector suitable for your Electric Vehicle and switch it off.
- Confirm the Charging Station status is normal and the status indicator is steady green.
- Select your preferred Language
- Remove the vehicle connector from the connector slot and insert firmly it into the corresponding charging port of the vehicle.
- Follow the instructions on the screen.

⚠ CAUTION

HAZARD OF DAMAGING A LOCKED VEHICLE CONNECTOR.

- In CCS charging the Electric Vehicle locks the vehicle connector.
 - If the user wants to unplug the vehicle connector from the car, it may be necessary to unlock all doors of the Electric Vehicle or use the "unlock charge connector button" on the car key, if present.
 - Do not apply force to a locked vehicle connector during charging. This might damage the inlet and locking mechanism in the car or damage the Charging Station.
 - Always handle cables and connectors with care & always place them back in their respective holders.
 - Only insert a vehicle connector into a suitable car inlet.
- Failure to follow these instructions can result in injury or equipment damage.**

PLEASE NOTE

- Always ensure that the vehicle connector is properly plugged in the Electric Vehicle.
- Always Ensure that the vehicle connector openings are clean and clear of any foreign bodies, dust, sand, leaves, etc.

2.2 Charging Authentication Modes

Depending on the configured authentication modes below, the user instructions for the charger may vary depending on the customer requirements:

1. Swipe Authorized Card to charge

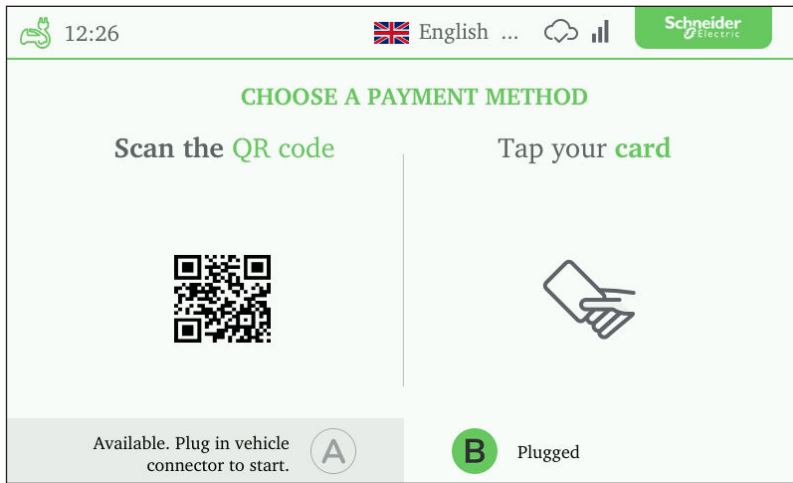

- A** • On the user interface of the Charging Station, select the suitable vehicle connector A or B and follow the instructions on the screen.
- B** • After inserting the vehicle connector in the Electric Vehicle port the user interface will prompt the user to tap the card. Once card is swiped on swiping area a charging session will start.

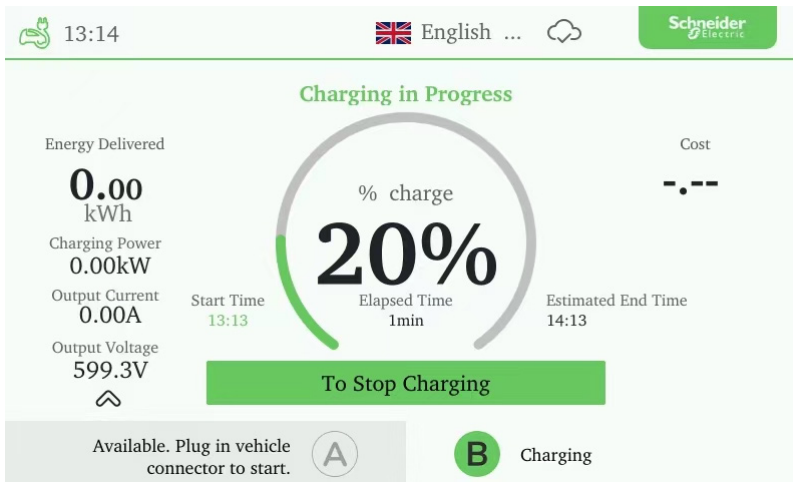

- C** • During charging, touch A and B buttons on the bottom of the screen to switch to the status interface of each vehicle connector.
- D** • Stop charging: Press "Stop Charging" to enter the stop charging interface and swipe the card again to stop charging.

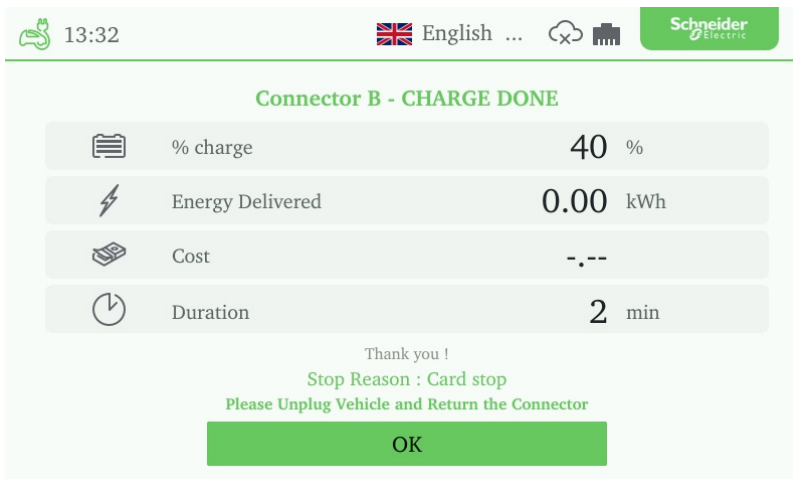

- E** • Unplug the vehicle connector from the vehicle, reposition it in the connector slot.

2.2 Charging Authentication Modes

2. Electric Vehicle MAC Address Authentication

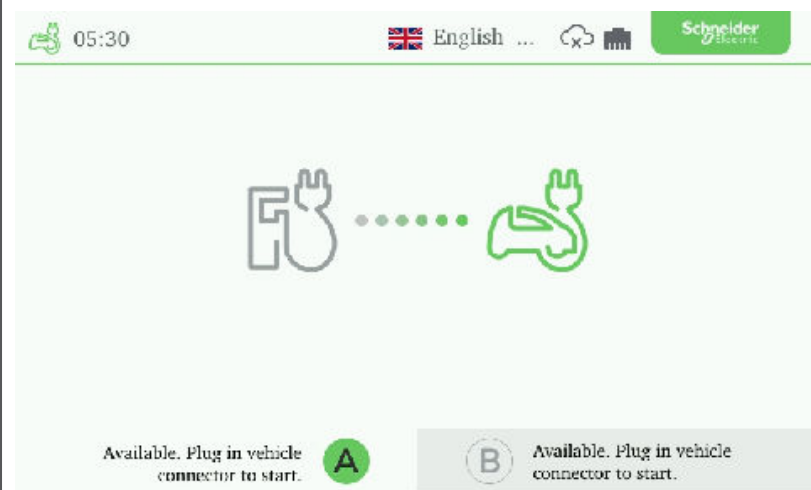

- A • On the User interface of the Charging Station, Select the suitable vehicle connector A or B and follow the instructions on the screen.
- B • Plug the vehicle connector into an authorized Electric Vehicle to authenticate.

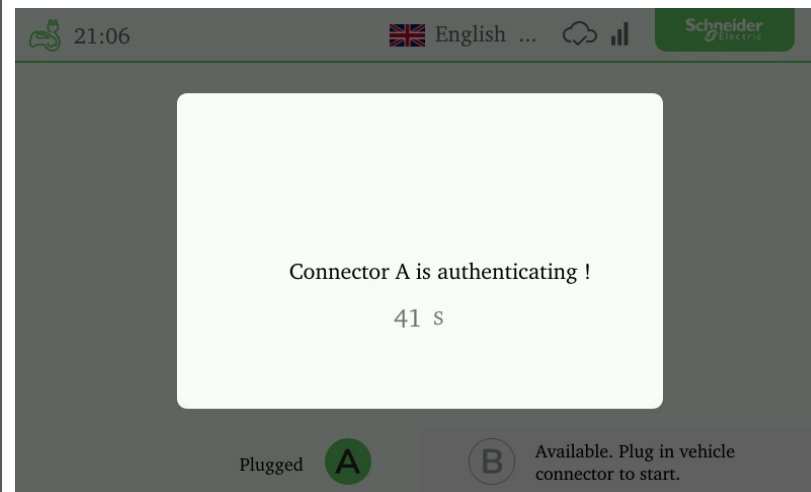

- C • If the Electric Vehicle is authorized, charging will start automatically. If the Electric Vehicle is not authorized a message will show on the HMI screen.
- D • To stop charge session, it must be ended from the EV side by using the unlock connector feature in the Electric Vehicle.
- E • After charging fully and stopping charging, charging results are displayed on the Charging Station screen.
- F • Unplug the vehicle connector from the vehicle, reposition it in the connector slot.

3. No Authentication

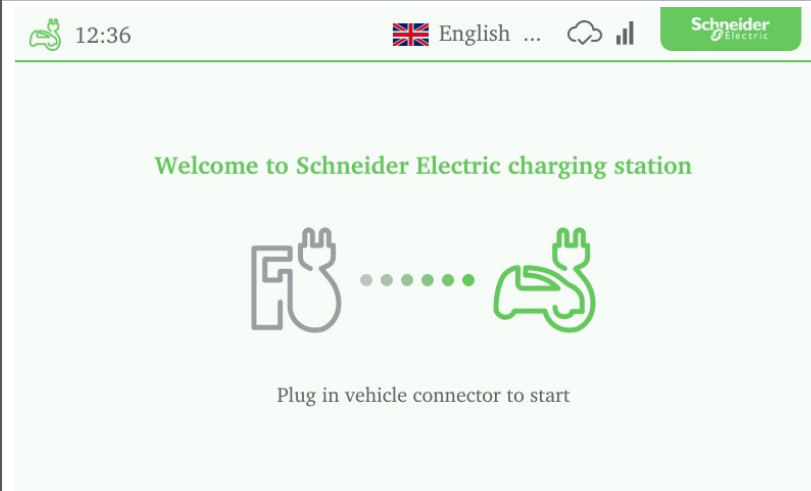

- A • On the user interface of the charging station, select the suitable vehicle connector A or B and follow the instructions on the screen.
- B • Remove the vehicle connector from the connector slot and insert firmly it into the corresponding charging port of the vehicle, charge session will start Automatically.
- C • To stop charge session, it must be ended from the Electric Vehicle side by using the unlock connector feature in the Electric Vehicle.
- D • Replace the connector in the holder.

3

Consumption Statistics

3.1 Charging Session Statistics

During the charging sessions the EVlink Pro DC can provide different readings and statistics about the ongoing session(s). To pick the charging session during charging, touch A and B buttons on the bottom of the screen to switch to the status interface of each vehicle connector.

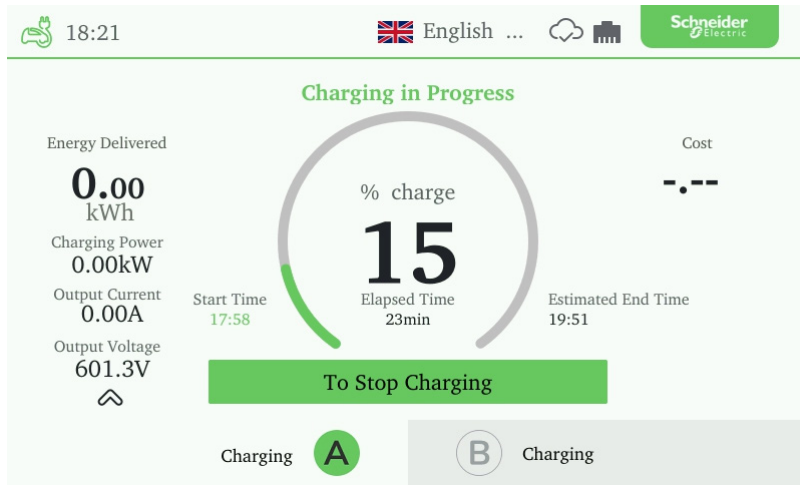

On the main screen of the Charging Station will appear the general status of the charging session such as:

- Session start time
- Elapsed time
- Estimated End Time
- Energy delivered in kWh
- Cost/billing amount (If applicable and provided by the CSMS)

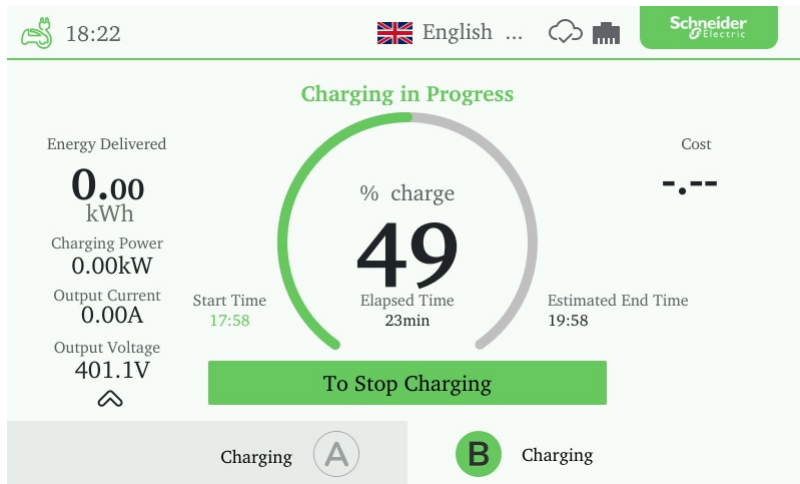

3.2 Charge Session Report

At the end of a charge session, the Charging Station will display on the user interface a report of the statistics of the charge session.

Session end

- Charging will stop without user interaction when the Electric Vehicle indicates to the charger that charging is completed.
- Charge session can also be ended from the Electric Vehicle side, refer to the Electric Vehicle owners manual.

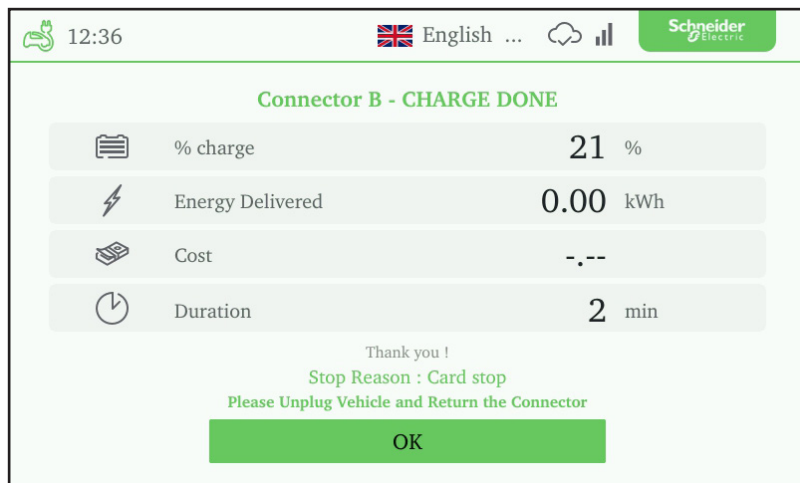

Available Information:

- Electric Vehicle battery Level in %
- Energy delivered in kWh
- Cost/billing information (if applicable) and provided by the CSMS
- Duration of charge session

4 Preventive Maintenance

⚠️ ⚠️ DANGER

HAZARD OF ELECTRIC SHOCK.

- Any inspection or maintenance activity that requires the Charging Station doors to be opened must only be performed by trained and authorized personnel.
 - Contact Schneider Electric services to provide the recommended service plan for your product.
- Failure to follow these instructions will result in death, serious injury, or equipment damage.**

NOTICE

RISK OF DAMAGING

- Do not apply high-pressure water jets when cleaning the charging station as water may leak inside.
 - Only use cleaning agents with a pH value between 6 and 8.
 - Do not use cleaning agents with abrasive components.
 - Do not use abrasive tools.
- Failure to follow these instructions can result in equipment damage.**

























To achieve the best performance out of your EVlink Pro DC Charging Station preventive maintenance plan is required. The preventive maintenance plan consists of regular maintenance and periodic maintenance.

Regular maintenance aims to offer a regular check for the status of the Charging Station under the condition when shut down is not possible.

Periodic maintenance is to be carried out at least once a year by Schneider Electric services personnel or trained and certified EcoXpert Schneider Electric's eMobility EcoXpert.

Regular Maintenance

Regular maintenance checklist as follow:

Regular Maintenance				
Check	Tool	Frequency	Shutdown Require	Status/Action
Visually check whether there are missing parts such as connector holder, charge interrupt button, handles, etc.		Weekly	No	
Visually check whether there are deformed or damaged parts on enclosure.		Weekly	No	
Ensure cleanliness of enclosure for stains, stickers, graffiti, grease, signs of rust, signs of burn or water penetration.		Weekly	No	
Check the HMI screen for damages and ensure proper visibility and touch response.		Weekly	No	
Test the QR code to ensure it is clear and leads to the correct App/Interface.		Weekly	No	
Check the HMI screen for any error messages.		Weekly	No	
Check the LED indicator lights.		Weekly	No	
Visually inspect the condition of the connectors and cables for any foreign objects, damages, or broken insulation.		Weekly	No	
Visually inspect the cable at the connector flange for any pull marks.		Weekly	No	
Manually test the proper operation of the cable management system and ensure that it can withdraw back a loose cable.		Weekly	No	
Inspect and verify the correct operation of the emergency charge stop.		Weekly	No	
Check the car stopping bollards are present and not damaged.		Weekly	No	
Visually inspect the concrete foundation and the pedestal for water collected or damages and ensure all bolts are secured in place.		Weekly	No	
Visually inspect the canopy/shed for any damages. (if applicable).		Weekly	No	
Ensure the installation area is clear of weeds, sand, excessive dust, etc.		Weekly	No	
Visually inspect all safety warning signs visible and clear.		Weekly	No	
Manually inspect the doors and locks for proper operation and keys are secured.		Weekly	No	
Listen whether there is abnormal noise from inside of the charger.	 	Weekly	No	
Check for abnormal (burning, rodent) smell coming from the charger.	 	Weekly	No	
Inspect the DC meter through the window and ensure clear reading visibility.		Weekly	No	
Inspect and clean the intake ventilation louvers for damages or any foreign objects blocking.		Weekly	No	
Inspect and clean the outlet ventilation grid for damages or any foreign objects blocking.		Weekly	No	



Product Disposal

To comply with Directive 2012/19/EU of the European Parliament and of the Council of 4 July 2012 on waste electrical and electronic equipment (WEEE), devices marked with this symbol may not be disposed of as part of unsorted domestic waste inside the European Union. Enquire with local authorities regarding proper disposal.

Product materials are recyclable as marked.

Radio Equipment Conformity

Hereby, Schneider Electric Industries, declares that this electric vehicle charging station EVlink Pro DC 60 is in compliance with the essential requirements and other relevant provisions of Radio Equipment Directives RED 2014/53/EU.

The EU declaration of conformity for EVlink Pro DC offer (EV24070301) can be downloaded on: se.com/ww/en/download

Hereby, Schneider Electric Industries, declares that this electric vehicle charging station EVlink Pro DC 60 is in compliance with the essential requirements and other relevant provisions of Radio Equipment Regulation SI 2017 No. 1206.

The UK declaration of conformity for EVlink Pro DC offer (EV24070301-UK) can be downloaded on: se.com/uk/en/download

Communication Frequencies

	Operation Frequency	Output Power
WiFi 2.4G	2412-2483.5 MHz	16.99 dBm
RFID:	13.56 MHz	Far less than 20 Mw
GSM900:	TX: 880 MHz to 915 MHz RX: 925 MHz to 960 MHz	26.63 dBm
GSM1800:	TX: 1710 MHz to 1785 MHz RX: 1805 MHz to 1880 MHz	24.77 dBm
WCDMA		
Band1:	TX: 1920 MHz to 1980 MHz RX: 2110 MHz to 2170 MHz	26.53 dBm
Band5:	TX: 824 MHz to 849 MHz RX: 869 MHz to 894 MHz	25.19 dBm
Band8:	TX: 880 MHz to 915 MHz RX: 925 MHz to 960 MHz	25.8 dBm
LTE		
Band1:	TX: 1920 MHz to 1980 MHz RX: 2110 MHz to 2170 MHz	26.53 dBm
Band3:	TX: 1710 MHz to 1785 MHz RX: 1805 MHz to 1880 MHz	26.99 dBm
Band5:	TX: 824 MHz to 849 MHz RX: 869 MHz to 894 MHz	25.19 dBm
Band7:	TX: 2500 MHz to 2570 MHz RX: 2620 MHz to 2690 MHz	27.99 dBm
Band8:	TX: 880 MHz to 915 MHz RX: 925 MHz to 960 MHz	25.8 dBm
Band20:	TX: 832MHz to 862 MHz RX: 791 MHz to 821MHz	25.44 dBm
Band28:	TX: 703 MHz to 748 MHz RX: 758 MHz to 803 MHz	26.81 dBm
Band38:	2570 MHz - 2620 MHz(TDD)	27.08 dBm
Band40:	2570 MHz - 2620 MHz(TDD)	26.9 dBm

Standards and Compliance

Directive RE: 2014/53/UE	RE Directive: 2014/53/EU
Directive RoHS: 2011/65/UE: 2015/863/UE	RoHS Directive: 2011/65/EU: 2015/863/EU

Based on following standards :

EN 61851-23: 2014 + AC1: 2016 and EN 61851-24: 2014 in conjunction with EN 61851-1: 2011 and EN IEC 61851-1 2019

EN 61000-6-2: 2005 + AC: 2005 (EN IEC 61000-6-2 : 2019*), EN 61000-6-4: 2007 + A1: 2011(EN IEC 61000-4 : 2019**)

EN 301 489-1 V2.2.3 (2019-11), EN 301 489-3 V2.1.1, (2017-03), EN 301 489-17 V3.2.4 (2020-09), EN 301 489-52 V1.2.1 (2021-11)

EN 300 328 V2.2.2 (2019-07), EN 300 330 V2.1.1 (2017-02), EN 301 511 V12.5.1 (2017-03), EN 301 908 -1 V15.1.1 (2021-09), EN 301 908 - 2 V13.1.1 (2020-06), EN 301 908 -13 V13.1.1 (2019-11)

EN 50364: 2010, EN 62311 :2020, EN 62479: 2010

EN IEC 63000: 2018

* The EN IEC 61000-6-2: 2019 is not an harmonized standard but the EVlink Pro DC 60kW is already compliant with EN IEC 61000-6-2: 2019.

** The EN IEC 61000-6-4: 2019 is not an harmonized standard but the EVlink Pro DC 60kW is already compliant with EN IEC 61000-6-4: 2019

